



# Mechanischer Jib 4t@1.5m

N. MAX ROPE 
4t
SINGLE ROPE 
5,5 t



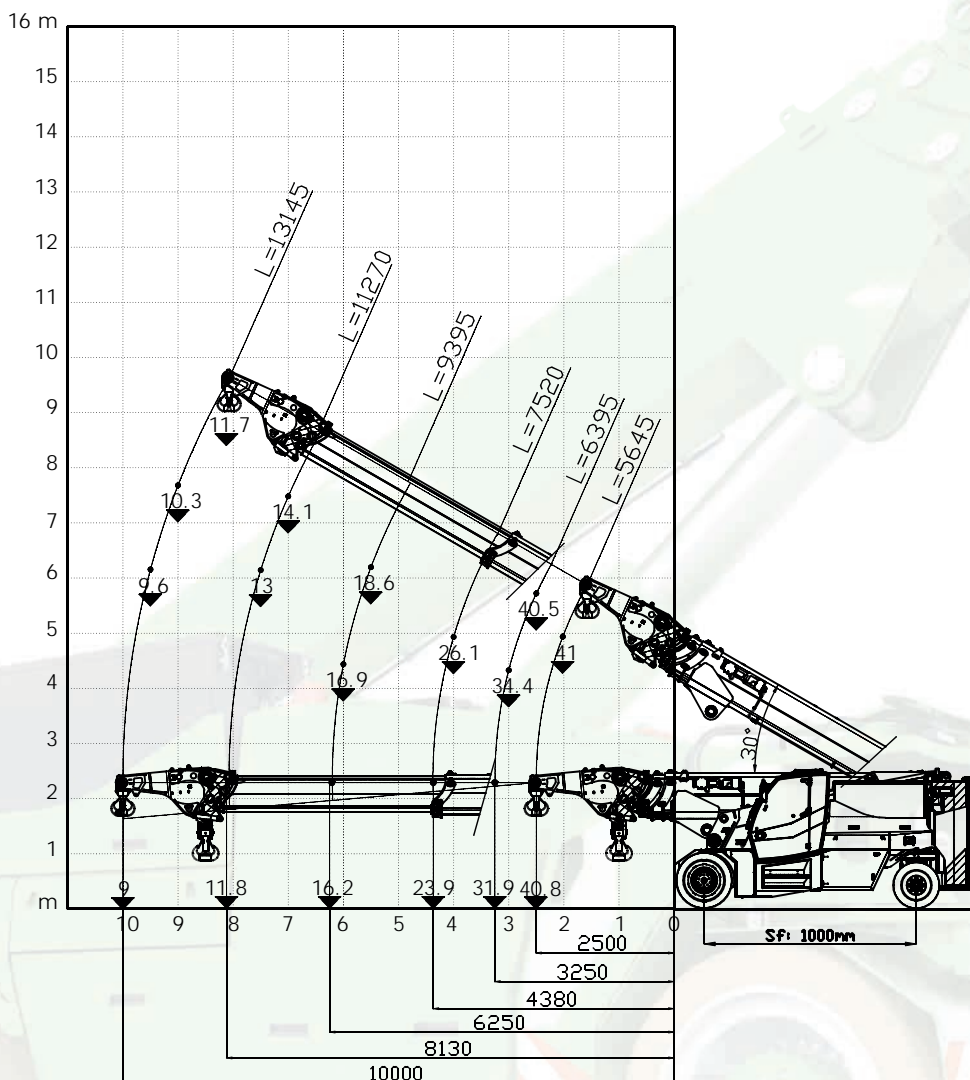

Lasttabellen



Mechanischer Jib 4t@1.5m  
 Haken / Seilwinde  
 Offene Gruppe bei 1000 mm  
 Position OBEN  
 4 Ballaste

Maximale Tragfähigkeit  
 Haken / Seilwinde: **4t**

# Mechanischer Jib 41t@1.5m

N. MAX ROPE	
41 t	
SINGLE ROPE	
5,5 t	



Lasttabellen

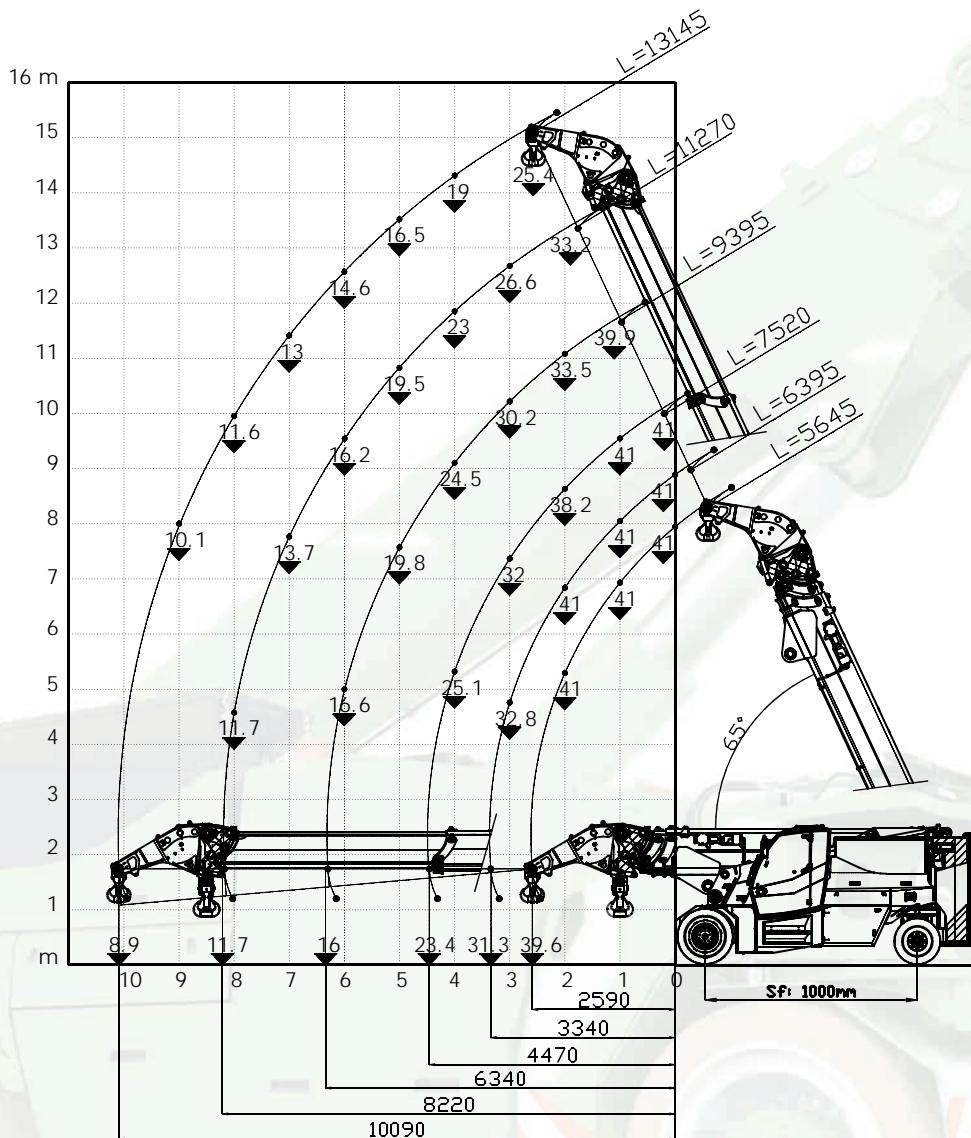

Mechanischer Jib 41t@1.5m

Haken / Seilwinde

Offene Gruppe bei 1000 mm



Position UNTEN

4 Ballaste

Maximale Tragfähigkeit  
Haken / Seilwinde: **41t**





# Mechanischer Jib 4t@1.5m





Maximale Tragfähigkeit  
Haken / Seilwinde: **4t**

N. MAX ROPE	
4t	
SINGLE ROPE	
5,5 t	



Lasttabellen

					Z1 Z2 Z3 Z4			
		1000mm	0mm					
	(t)	5645	6395	7520	9395	11270	13145	
	0							
	0,5							
	1							
	1,5							
	2	41						
	2,5	40,8	40,5					
	3		34,4					
	3,25		31,9	32				
	3,5			29,7				
	4			26,1				
	4,38			23,9				
	4,5							
	5					20,6		
	5,5					18,6		
	6					16,9		
	6,25					16,2		
6,5						15,4		
7						14,1		
7,5						13		
8						12,1		
8,13						11,8	11,7	
8,5							11,1	
9							10,3	
9,5							9,6	
10							9	



					NZ			
		1000mm	600mm					
	(t)	5645	6395	7520	9395	11270	13145	
	0							
	0,5							
	1							
	1,5							
	2	41						
	2,5	36,7	36,4					
	3		28,3					
	3,25		25,4	25				
	3,5			22,7				
	4			18,9				
	4,38			16,7				
	4,5							
	5					13,8		
	5,5					12,1		
	6					10,7		
	6,25					10		
6,5						9,3		
7						8,2		
7,5						7,4		
8						6,7		
8,13						6,5	6,4	
8,5							5,9	
9							5,3	
9,5							4,8	
10							4,4	

Mechanischer Jib 4t@1.5m  
Haken / Seilwinde  
Offene Gruppe bei 1000 mm  
Position OBEN  
4 Ballaste





Mechanischer Jib 4t@1.5m  
Haken / Seilwinde  
Offene Gruppe bei 1000 mm  
Position OBEN  
Offene Stab. bei 600 mm





# Mechanischer Jib 4t@1.5m

Maximale Tragfähigkeit  
Haken / Seilwinde: **4t**

N. MAX ROPE	
4t	
SINGLE ROPE	
5,5 t	

 Lasttabellen



   							
							
	(t)	5645	6395	7520	9395	11270	13145
0	41	41	41				
0,5	41	41	41	39,9			
1	41	41	41	37,8	33,2		
1,5	41	41	39,9	35,5	32,7		
2	41	41	38,2	33,5	30,6	25,4	
2,5	39,2	37,6	36,7	31,7	28,6	24	
2,59	39,6	36,7	36	31,4	28,2	23,7	
3		32,8	32	30,2	26,6	22,1	
3,34		31,3	29,2	28,8	25,2	21	
3,5			28	27,5	24,7	20,5	
4			25,1	24,5	23	19	
4,47			23,4	22	21,6	17,8	
4,5				22	21,5	17,7	
5				19,8	19,5	16,5	
5,5				18	17,8	15,5	
6				16,6	16,2	14,6	
6,34				16	15,3	14	
6,5					14,9	13,7	
7					13,7	13	
7,5					12,8	12,3	
8					11,7	11,6	
8,22					11,7	11,4	
8,5						10,9	
9						10,1	
9,5						9,5	
10						8,9	
10,09						8,9	

   							
							
	(t)	5645	6395	7520	9395	11270	13145
0	41	41	41				
0,5	41	41	41	39,9			
1	41	41	41	37,8	33,2		
1,5	41	41	39,9	35,5	32,7		
2	41	41	38,2	33,5	30,6	25,4	
2,5	34,8	32,5	31,4	31,3	28,6	24	
2,59	35,1	31,3	30,3	30,1	28,2	23,7	
3		26,5	25,3	25,1	24,8	22,1	
3,34		24,6	22,4	22,1	21,8	21	
3,5			21,1	20,9	20,6	20,3	
4			18	17,7	17,3	17,1	
4,47			16,3	15,4	15,1	14,8	
4,5				15,2	14,9	14,7	
5				13,2	13	12,8	
5,5				11,7	11,4	11,2	
6				10,4	10,1	10	
6,34				9,8	9,3	9,2	
6,5					9	8,9	
7					8,1	7,9	
7,5					7,3	7,1	
8					6,5	6,5	
8,22					6,5	6,2	
8,5						5,8	
9						5,3	
9,5						4,8	
10						4,4	
10,09						4,4	

Mechanischer Jib 4t@1.5m  
Haken / Seilwinde  
Offene Gruppe bei 1000 mm  
Position UNTEN  
4 Ballaste

Mechanischer Jib 4t@1.5m  
Haken / Seilwinde  
Offene Gruppe bei 1000 mm  
Position UNTEN  
Offene Stab. bei 600 mm

# Verlängerung 20t@1.5m am mechanischen Jib 4t@1.5m

N. MAX ROPE	
20 t	
SINGLE ROPE	
5,5 t	



Lasttabellen

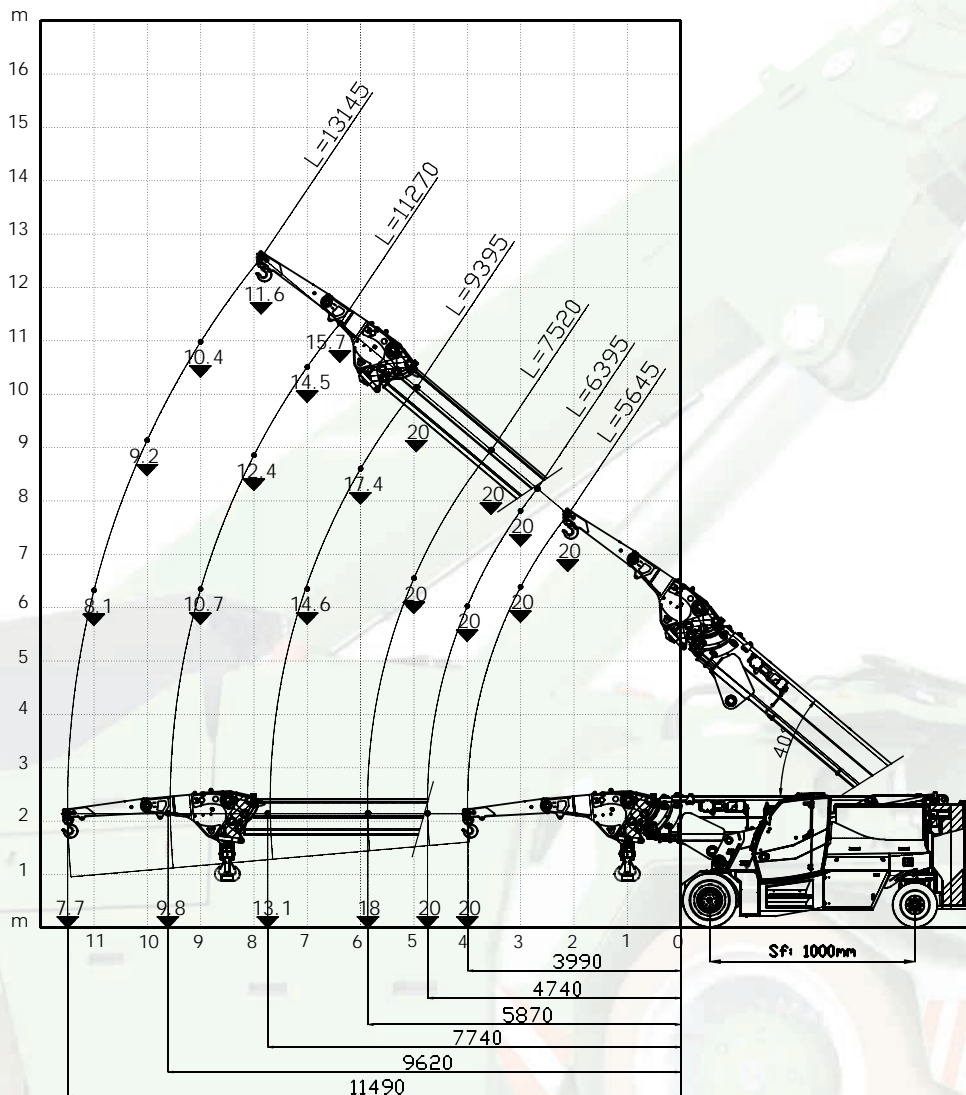

Verlängerung 20t@1.5m  
am mechanischen Jib 4t@1.5m

Haken / Seilwinde



Offene Gruppe bei 1000 mm

Position OBEN

4 Ballaste

Maximale Tragfähigkeit  
Haken / Seilwinde: **20t**

# Verlängerung 20t@1.5m am mechanischen Jib 4t@1.5m

N. MAX ROPE	
20 t	
SINGLE ROPE	
5,5 t	



Lasttabellen

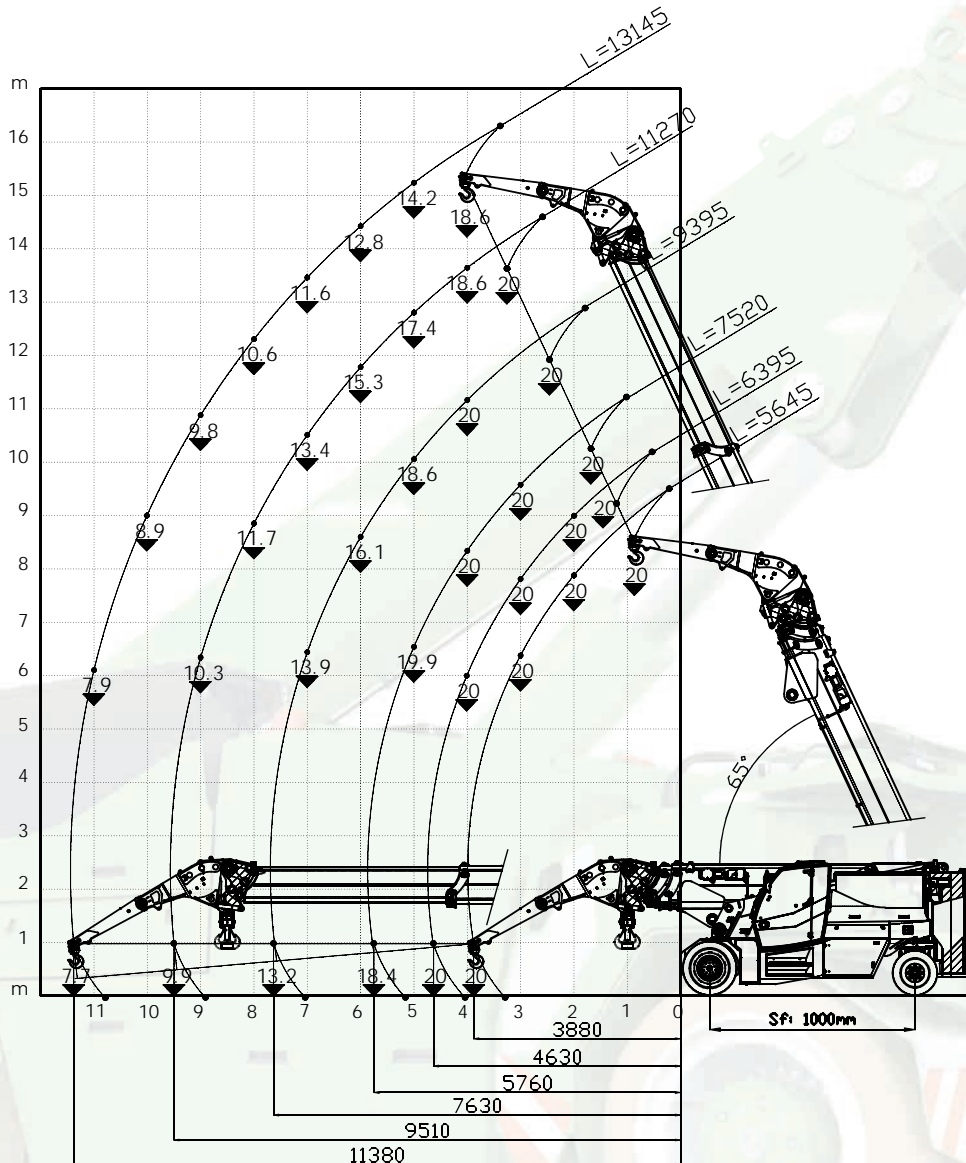

Verlängerung 20t@1.5m  
am mechanischen Jib 4t@1.5m

Haken / Seilwinde

Offene Gruppe bei 1000 mm



Position UNTEN

4 Ballaste

Maximale Tragfähigkeit  
Haken / Seilwinde: 20t







# Verlängerung 20t@1.5m am mechanischen Jib 4t@1.5m







Maximale Tragfähigkeit  
Haken / Seilwinde: 20t

N. MAX ROPE ↙	
20 t	
SINGLE ROPE ↘	
5,5 t	



Lasttabellen

							
		1000mm	0mm	Z1	Z2	Z3	Z4
	(t)	5645	6395	7520	9395	11270	13145
	0						
	0,5						
	1						
	1,5						
	2						
	2,5	20					
	3	20	20				
	3,5	20	20				
	3,99	20	20	20			
	4		20	20			
	4,5		20	20			
	4,74		20	20			
	5			20	20		
	5,5			19,5	19,1		
	5,87			18	17,9		
	6				17,4		
	6,5				16	15,7	
	7				14,6	14,5	
	7,5				13,5	13,3	
	7,74				13,1	12,9	
	8					12,4	11,6
	8,5					11,5	11
	9					10,7	10,4
	9,5					10	9,9
	9,62					9,8	9,8
	10						9,2
	10,5						8,7
	11						8,1
	11,49						7,7



							
		1000mm	600mm	NZ			
	(t)	5645	6395	7520	9395	11270	13145
	0						
	0,5						
	1						
	1,5						
	2						
	2,5	20					
	3	20	20				
	3,5	20	20				
	3,99	20	20	19,9			
	4		20	19,8			
	4,5		17,3	17			
	4,74		16	15,7			
	5			14,6	14,6		
	5,5			12,9	12,8		
	5,87			11,8	11,6		
	6				11,3		
	6,5				10	9,8	
	7				9	8,8	
	7,5				8,1	7,9	
	7,74				7,7	7,5	
	8					7,1	7
	8,5					6,4	6,3
	9					5,9	5,7
	9,5					5,3	5,2
	9,62					5,2	5,1
	10						4,7
	10,5						4,3
	11						3,9
	11,49						3,6

Verlängerung 20t@1.5m  
am mechanischen Jib 4t@1.5m  
Haken / Seilwinde  
Offene Gruppe bei 1000 mm  
Position OBEN  
4 Ballaste

Verlängerung 20t@1.5m  
am mechanischen Jib 4t@1.5m  
Haken / Seilwinde  
Offene Gruppe bei 1000 mm  
Position OBEN  
Offene Stab. bei 600 mm







# Verlängerung 20t@1.5m am mechanischen Jib 4t@1.5m







Maximale Tragfähigkeit  
Haken / Seilwinde: 20t

N. MAX ROPE ↙	
20 t	
SINGLE ROPE ↘	
5,5 t	



Lasttabellen



							
		1000mm	0mm	Z1	Z2	Z3	Z4
							
	(t)	5645	6395	7520	9395	11270	13145
	0	20	20	20			
	0,5	20	20	20			
	1	20	20	20	20		
	1,5	20	20	20	20	20	
	2	20	20	20	20	20	
	2,5	20	20	20	20	20	18,6
	3	20	20	20	20	20	18
	3,5	20	20	20	20	19,3	16,9
	3,88	20	20	20	20	18,8	16,2
	4		20	20	20	18,6	15,9
	4,5		20	20	20	18	15
	4,63		20	20	19,8	17,8	14,8
	5			19,9	18,6	17,4	14,2
	5,5			18,4	17,3	16,5	13,4
	5,76			18,4	16,6	15,8	13,1
	6				16,1	15,3	12,8
	6,5				15	14,3	12,2
	7				13,9	13,4	11,6
	7,5				13,3	12,5	11,1
	7,63				13,2	12,3	10,9
	8					11,7	10,6
	8,5					11	10,2
	9					10,3	9,8
	9,5					9,9	9,4
	9,51					9,9	9,4
	10						8,9
	10,5						8,4
	11						7,9
	11,38						7,7

							
		1000mm	600mm	NZ			
							
	(t)	5645	6395	7520	9395	11270	13145
	0	20	20	20			
	0,5	20	20	20			
	1	20	20	20	20		
	1,5	20	20	20	20	20	
	2	20	20	20	20	20	
	2,5	20	20	20	20	20	18,6
	3	20	20	20	20	19,3	18
	3,5	20	20	18,7	17,6	16,7	16,2
	3,88	20	18,5	17,1	16	15,2	14,6
	4		17,9	16,6	15,5	14,7	14,2
	4,5		16,6	15	13,8	13	12,6
	4,63		16,5	14,6	13,4	12,7	12,2
	5			13,4	12,4	11,7	11,3
	5,5			12,1	11,3	10,5	10,1
	5,76			12,1	10,7	10	9,6
	6				10,3	9,5	9,1
	6,5				9,3	8,7	8,3
	7				8,4	7,9	7,5
	7,5				7,8	7,3	6,9
	7,63				7,8	7,1	6,7
	8					6,7	6,3
	8,5					6,1	5,8
	9					5,6	5,3
	9,5					5,3	4,9
	9,51					5,3	4,9
	10						4,5
	10,5						4,1
	11						3,8
	11,38						3,6

Verlängerung 20t@1.5m  
am mechanischen Jib 4t@1.5m  
Haken / Seilwinde  
Offene Gruppe bei 1000 mm  
Position UNTEN  
4 Ballaste

Verlängerung 20t@1.5m  
am mechanischen Jib 4t@1.5m  
Haken / Seilwinde  
Offene Gruppe bei 1000 mm  
Position UNTEN  
Offene Stab. bei 600 mm

# Gelenk-Jib 35t@1.85m

N. MAX ROPE	
35 t	
SINGLE ROPE	
5,5 t	



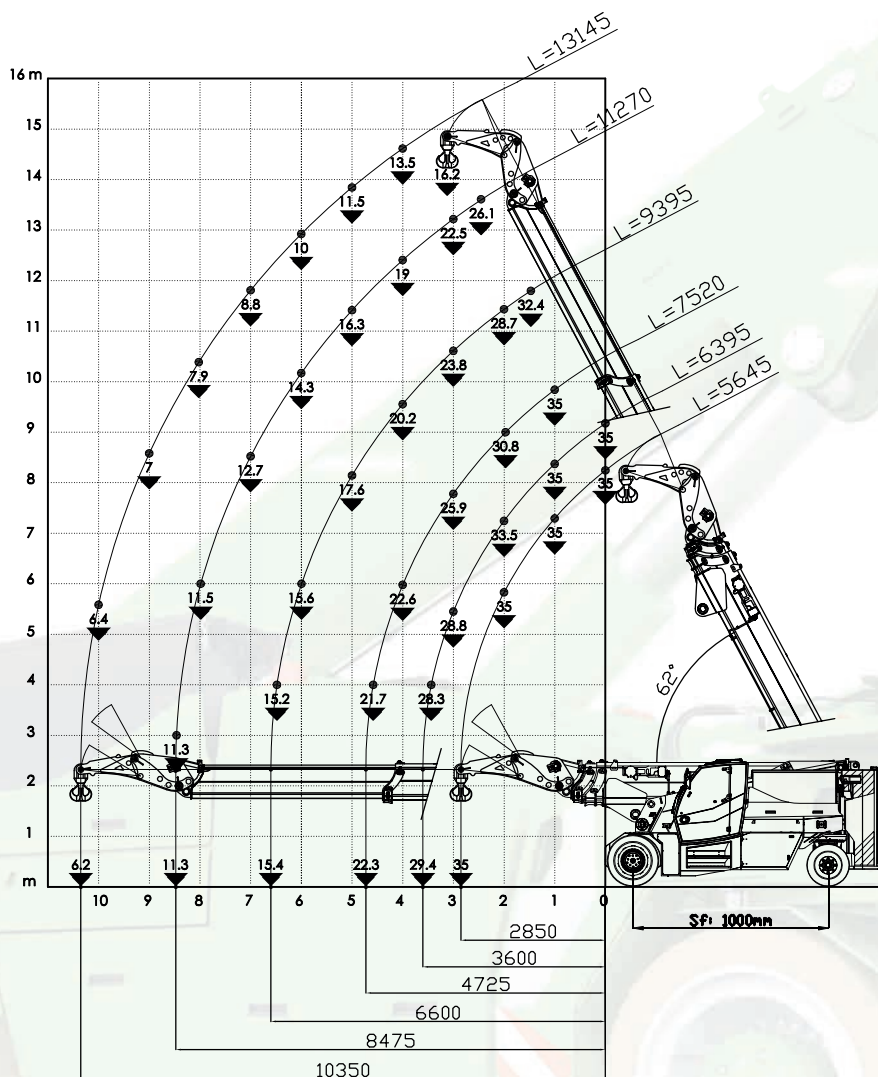

Lasttabellen



Gelenk-Jib 35t@1.85m  
 Haken / Seilwinde  
 Offene Gruppe bei 1000 mm  
 Position OBEN  
 4 Ballaste

Maximale Tragfähigkeit  
 Haken / Seilwinde: **35t**

# Gelenk-Jib 35t@1.85m

N. MAX ROPE	
35 t	
SINGLE ROPE	
5,5 t	



Lasttabellen

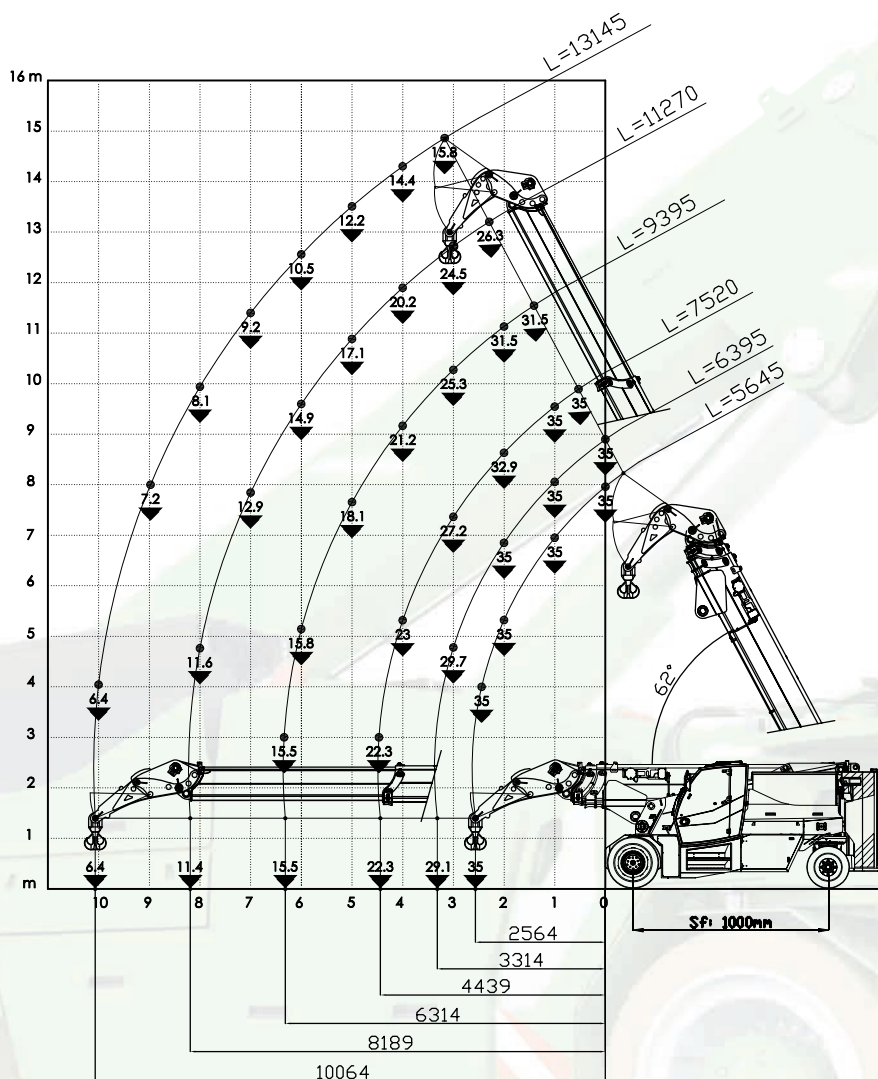



Gelenk-Jib 35t@1.85m  
 Haken / Seilwinde  
 Offene Gruppe bei 1000 mm  
 Position UNTEN  
 4 Ballaste

Maximale Tragfähigkeit  
 Haken / Seilwinde: **35t**





# Gelenk-Jib 35t@1.85m





Maximale Tragfähigkeit  
Haken / Seilwinde: **35t**

N. MAX ROPE	
35 t	
SINGLE ROPE	
5,5 t	



Lasttabellen

					Z1 Z2 Z3 Z4
					
(t)	5645	6395	7520	9395	11270 13145
0,01	35	35	35		
0,5	35	35	35		
1	35	35	35		
1,5	35	35	34,3	32,4	
2	35	33,5	30,8	28,7	
2,5	34,6	31	28	26,1	24,8
2,85	35	29,4	26,6	24,5	23,2 16,7
3		28,8	25,9	23,8	22,5 16,2
3,5		28,3	24,1	21,8	20,7 14,7
3,6		29,4	23,9	21,3	20,3 14,5
4			22,6	20,2	19 13,5
4,5			21,7	18,7	17,6 12,4
4,73			22,3	18,3	17 12
5				17,6	16,3 11,5
5,5				16,5	15,2 10,7
6				15,6	14,3 10
6,5				15,2	13,5 9,4
6,6				15,4	13,3 9,3
7					12,7 8,8
7,5					12 8,3
8					11,5 7,9
8,48					11,3 7,5
8,5					7,5
9					7
9,5					6,7
10					6,4
10,35					6,2

					NZ
					
(t)	5645	6395	7520	9395	11270 13145
0,01	35	35	35		
0,5	35	35	35		
1	35	35	34		
1,5	35	31,6	28,3	26,3	
2	31,6	27,5	24,3	22,4	
2,5	28,8	24,5	21,3	19,4	18,2
2,85	31	22,8	19,6	17,7	16,6 16
3		22,1	19,1	17,1	16 15,4
3,5		21,3	17,2	15,2	14,1 13,5
3,6		22,4	16,9	14,9	13,9 13,2
4			15,7	13,7	12,7 12,1
4,5			14,8	12,4	11,4 10,8
4,73			15,3	11,9	10,9 10,4
5				11,4	10,3 9,7
5,5				10,4	9,4 8,9
6				9,7	8,7 8,1
6,5				9,2	8 7,4
6,6				9,4	7,8 7,3
7					7,3 6,8
7,5					6,8 6,3
8					6,4 5,8
8,48					6,2 5,4
8,5					5,3
9					5
9,5					4,6
10					4,3
10,35					4,2

Gelenk-Jib 35t@1.85m

Haken / Seilwinde

Offene Gruppe bei 1000 mm

Position OBEN

4 Ballaste

Gelenk-Jib 35t@1.85m

Haken / Seilwinde



Offene Gruppe bei 1000 mm

Position OBEN

Offene Stab. bei 600 mm





# Gelenk-Jib 35t@1.85m





Maximale Tragfähigkeit  
Haken / Seilwinde: **35t**

N. MAX ROPE	
35 t	
SINGLE ROPE	
5,5 t	



Lasttabellen

				Z1 Z2	Z3 Z4		
							
	(t)	5645	6395	7520	9395	11270	13145
0,01	35	35					
0,5	35	35					
1	35	35	35				
1,5	35	35	35				
2	35	35	32,9	31,5			
2,5	35	32,1	29,7	28			
2,56	35	31,9	29,4	27,8	26,3		
3		29,7	27,2	25,3	24,5		
3,31		29,1	25,8	23,9	22,9		
3,5			25	23,2	22,1	15,8	
4			23	21,2	20,2	14,4	
4,44			22,3	19,7	18,8	13,3	
4,5				19,5	18,5	13,2	
5				18,1	17,1	12,2	
5,5				16,8	16	11,3	
6				15,8	14,9	10,5	
6,31				15,5	14,2	10	
6,5					13,9	9,8	
7					12,9	9,2	
7,5					12,3	8,6	
8					11,6	8,1	
8,19					11,4	7,9	
8,5						7,6	
9						7,2	
9,5						6,8	
10						6,4	
10,06						6,4	

				NZ			
							
	(t)	5645	6395	7520	9395	11270	13145
0,01	35	35					
0,5	35	35					
1	35	35	35				
1,5	35	35	32,1				
2	33,2	29,7	26,9	25,5			
2,5	29,9	25,8	23	21,6			
2,56	29,9	25,2	22,6	21,2	20,2		
3		22,8	20,3	18,7	17,8		
3,31		22,1	18,8	17,2	16,4		
3,5			18	16,5	15,6	15,1	
4			16,2	14,6	13,8	13,3	
4,44			15,3	13,3	12,5	12	
4,5				13,2	12,3	11,8	
5				11,9	11,1	10,6	
5,5				10,7	10	9,6	
6				9,9	9,1	8,7	
6,31				9,5	8,6	8,2	
6,5					8,3	7,9	
7					7,5	7,2	
7,5					6,9	6,6	
8					6,4	6	
8,19					6,3	5,8	
8,5						5,5	
9						5,1	
9,5						4,7	
10						4,3	
10,06						4,3	

Gelenk-Jib 35t@1.85m

Haken / Seilwinde

Offene Gruppe bei 1000 mm

Position UNTEN

4 Ballaste

Gelenk-Jib 35t@1.85m



Haken / Seilwinde

Offene Gruppe bei 1000 mm

Position UNTEN

Offene Stab. bei 600 mm

# Verlängerung 20t@1.5m am Gelenk-Jib 35t@1.85m

N. MAX ROPE	
20 t	
SINGLE ROPE	
5,5 t	



Lasttabellen

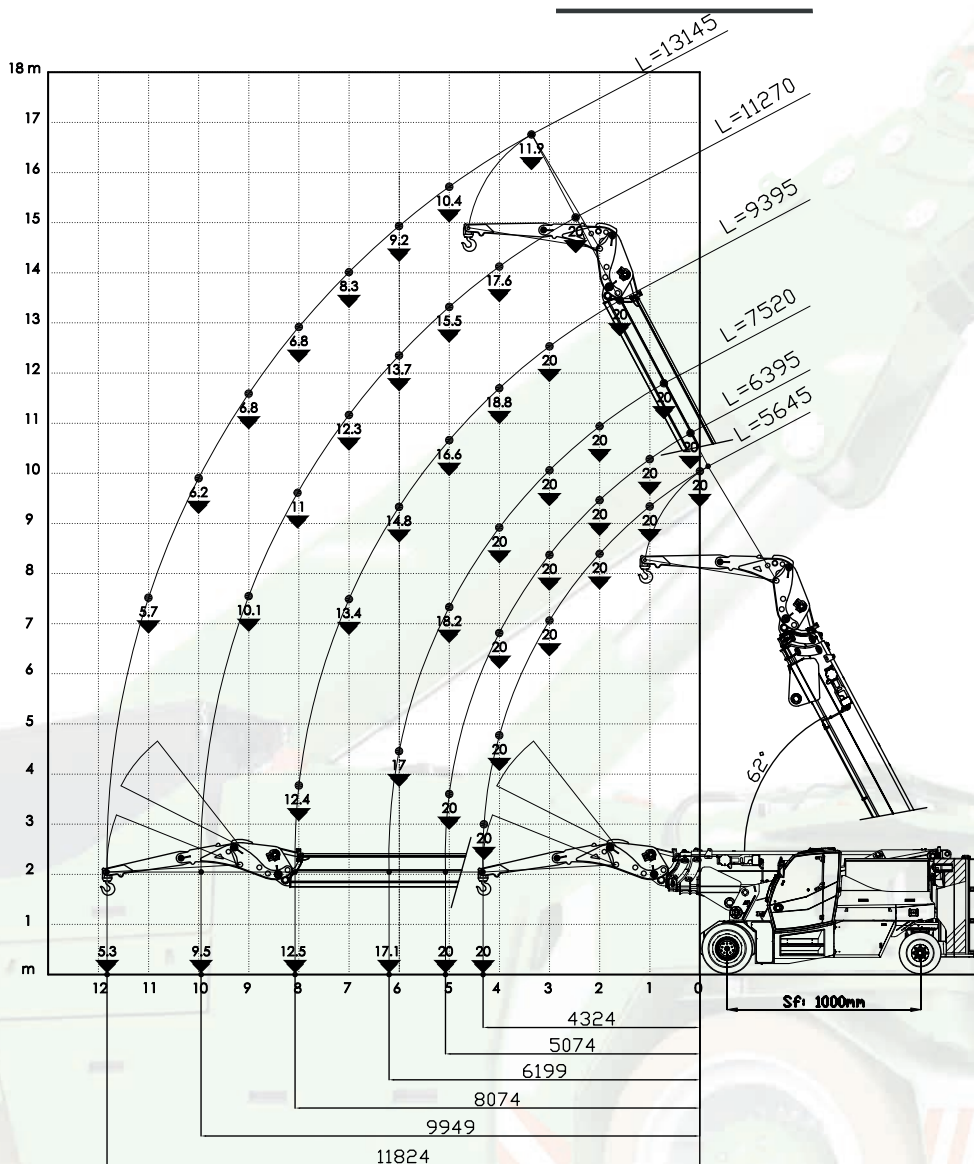

Verlängerung 20t@1.5m  
am Gelenk-Jib 35t@1.85m  
Haken / Seilwinde  
Offene Gruppe bei 1000 mm  
Position OBEN  
4 Ballaste

Maximale Tragfähigkeit  
Haken / Seilwinde: **20t**

# Verlängerung 20t@1.5m am Gelenk-Jib 35t@1.85m

N. MAX ROPE	
20 t	
SINGLE ROPE	
5,5 t	



Lasttabellen

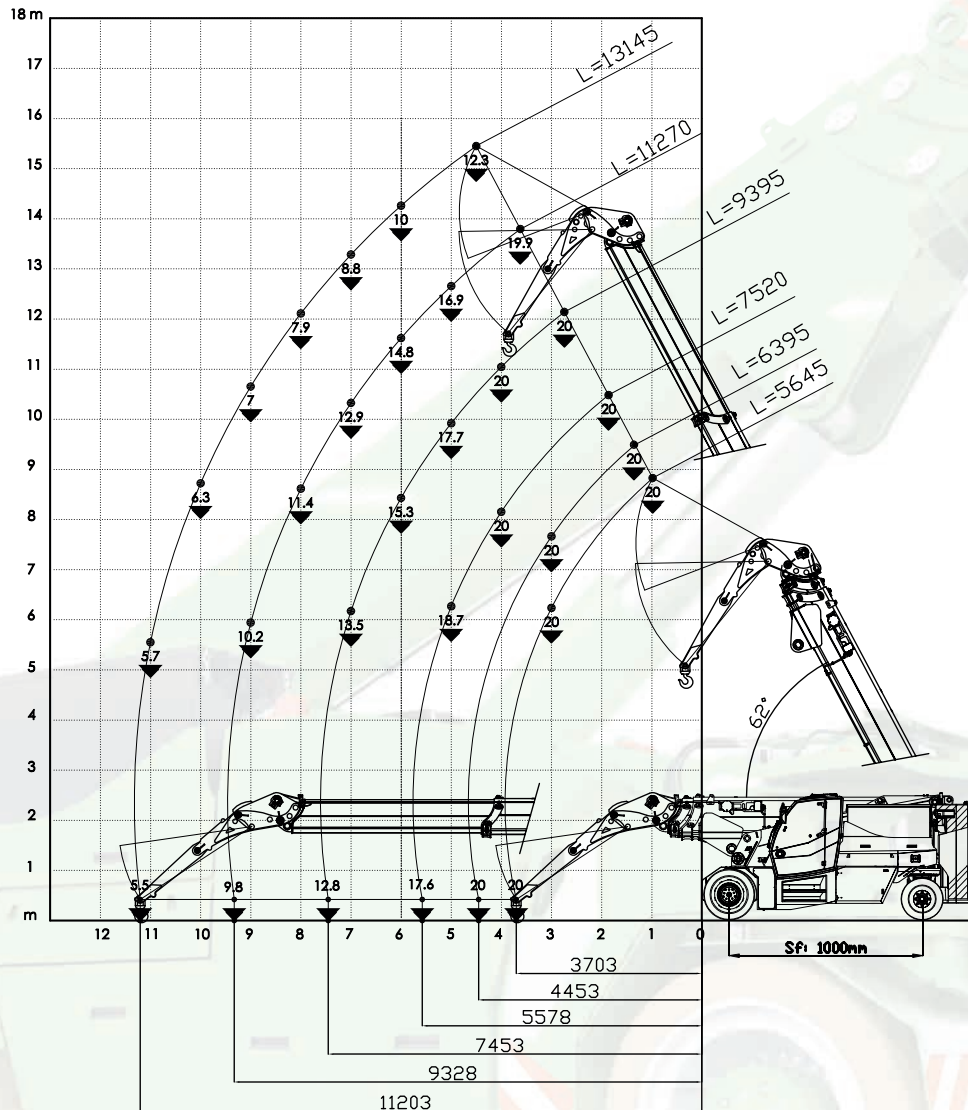



Verlängerung 20t@1.5m  
am Gelenk-Jib 35t@1.85m  
Haken / Seilwinde  
Offene Gruppe bei 1000 mm  
Position UNTEN  
4 Ballaste

Maximale Tragfähigkeit  
Haken / Seilwinde: **20t**









# Verlängerung 20t@1.5m am Gelenk-Jib 35t@1.85m







Maximale Tragfähigkeit  
Haken / Seilwinde: 20t

N. MAX ROPE ↙	
20 t	
SINGLE ROPE ↘	
5,5 t	



Lasttabellen

							
		0mm	SFILO 1000	Z1 Z2	Z3 Z4		
	(t)	5645	6395	7520	9395	11270	13145
	0,01	20					
	0,5	20					
	1	20	20				
	1,5	20	20	20			
	2	20	20	20			
	2,5	20	20	20	20		
	3	20	20	20	20	20	
	3,5	20	20	20	20	18,9	
	4	20	20	20	18,8	17,6	11,9
	4,32	20	20	19,8	18	16,9	11,4
	4,5		20	19,3	17,6	16,5	11,1
	5		20	18,2	16,6	15,5	10,4
	5,07		20	18,2	16,5	15,3	10,3
	5,5			17,4	15,6	14,6	9,8
	6			17	14,8	13,7	9,2
	6,20			17,1	14,5	13,4	9
	6,5				14	13,1	8,7
	7				13,4	12,3	8,3
	7,5				12,8	11,7	7,9
	8				12,4	11	7,5
	8,07				12,5	11	7,4
	8,5					10,5	7,1
	9					10,1	6,8
	9,5					9,7	6,4
	9,95					9,5	6,2
	10						6,2
	10,5						5,9
	11						5,7
	11,5						5,4
	11,82						5,3



							
		600mm	SFILO 1000	NZ			
	(t)	5645	6395	7520	9395	11270	13145
	0,01	20					
	0,5	20					
	1	20	20				
	1,5	20	20	20			
	2	20	20	20			
	2,5	20	20	18,4	17,1		
	3	20	18,7	16,8	15,4	14,3	
	3,5	18,8	17	15,4	13,9	13	
	4	18	15,7	14,2	12,8	11,8	11,2
	4,32	18,2	15,1	13,4	12,1	11,1	10,6
	4,5		14,9	13	11,8	10,8	10,2
	5		14,4	12,1	10,9	9,9	9,3
	5,07		14,6	12	10,7	9,8	9,2
	5,5			11,4	10	9,2	8,5
	6			11	9,3	8,5	7,9
	6,20			11	9	8,2	7,6
	6,5				8,7	7,8	7,3
	7				8,1	7,3	6,8
	7,5				7,7	6,8	6,3
	8				7,3	6,3	5,8
	8,07				7,4	6,2	5,8
	8,5					5,9	5,4
	9					5,5	5
	9,5					5,2	4,7
	9,95					5	4,4
	10						4,3
	10,5						4,1
	11						3,8
	11,5						3,6
	11,82						3,5

Verlängerung 20t@1.5m  
am Gelenk-Jib 35t@1.85m  
Haken / Seilwinde  
Offene Gruppe bei 1000 mm  
Position OBEN  
4 Ballaste

Verlängerung 20t@1.5m  
am Gelenk-Jib 35t@1.85m  
Haken / Seilwinde  
Offene Gruppe bei 1000 mm  
Position OBEN  
Offene Stab. bei 600 mm







# Verlängerung 20t@1.5m am Gelenk-Jib 35t@1.85m





Maximale Tragfähigkeit  
Haken / Seilwinde: 20t

N. MAX ROPE ↗	
20 t	
SINGLE ROPE ↘	
5,5 t	



Lasttabellen

								
	0mm						SFILO 1000	Z1 Z2 Z3 Z4
	(t)	5645	6395	7520	9395	11270	13145	
0,01								
0,5								
1								
1,5	20							
2	20	20						
2,5	20	20	20					
3	20	20	20					
3,5	20	20	20	20				
3,70	20	20	20	20	20	19,9		
4		20	20	20	20	19,3		
4,45		20	20	20	19,1	18,3		
4,5		20	20	19	18,2	12,3		
5			18,7	17,7	16,9	11,4		
5,5			17,7	16,5	15,8	10,6		
5,58			17,6	16,3	15,6	10,5		
6				15,3	14,8	10		
6,5				14,4	13,9	9,4		
7				13,5	12,9	8,8		
7,45				12,9	12,1	8,4		
7,5				12,8	12,1	8,3		
8					11,4	7,9		
8,5					10,8	7,4		
9					10,2	7		
9,33					9,8	6,7		
9,5						6,6		
10						6,3		
10,5						6		
11						5,7		
11,20						5,5		

								
	600mm						SFILO 1000	NZ
	(t)	5645	6395	7520	9395	11270	13145	
0,01								
0,5								
1								
1,5	20							
2	20	20						
2,5	20	20	20					
3	20	20	18,7					
3,5	19,3	18	17	16				
3,70	18,8	17,3	16,2	15,3	14,5			
4		16,3	15,2	14,3	13,6			
4,45		15,3	13,9	13,1	12,4			
4,5		15,2	13,7	13	12,3	11,9		
5			12,5	11,8	11,1	10,7		
5,5			11,6	10,7	10,1	9,7		
5,58			11,5	10,6	10	9,6		
6				9,8	9,3	8,9		
6,5				8,9	8,5	8,1		
7				8,2	7,8	7,5		
7,45				7,6	7,2	6,9		
7,5				7,6	7,1	6,8		
8					6,5	6,3		
8,5					6	5,8		
9					5,6	5,3		
9,33					5,2	5		
9,5						4,9		
10						4,5		
10,5						4,1		
11						3,8		
11,20						3,6		

Verlängerung 20t@1.5m  
am Gelenk-Jib 35t@1.85m  
Haken / Seilwinde  
Offene Gruppe bei 1000 mm  
Position UNTEN  
4 Ballaste

Verlängerung 20t@1.5m  
am Gelenk-Jib 35t@1.85m  
Haken / Seilwinde  
Offene Gruppe bei 1000 mm  
Position UNTEN  
Offene Stab. bei 600 mm

# Verlängerung 7t@3m am Gelenk-Jib 35t@1.85m

N. MAX ROPE 2	
7 t	
SINGLE ROPE 1	
5,5 t	



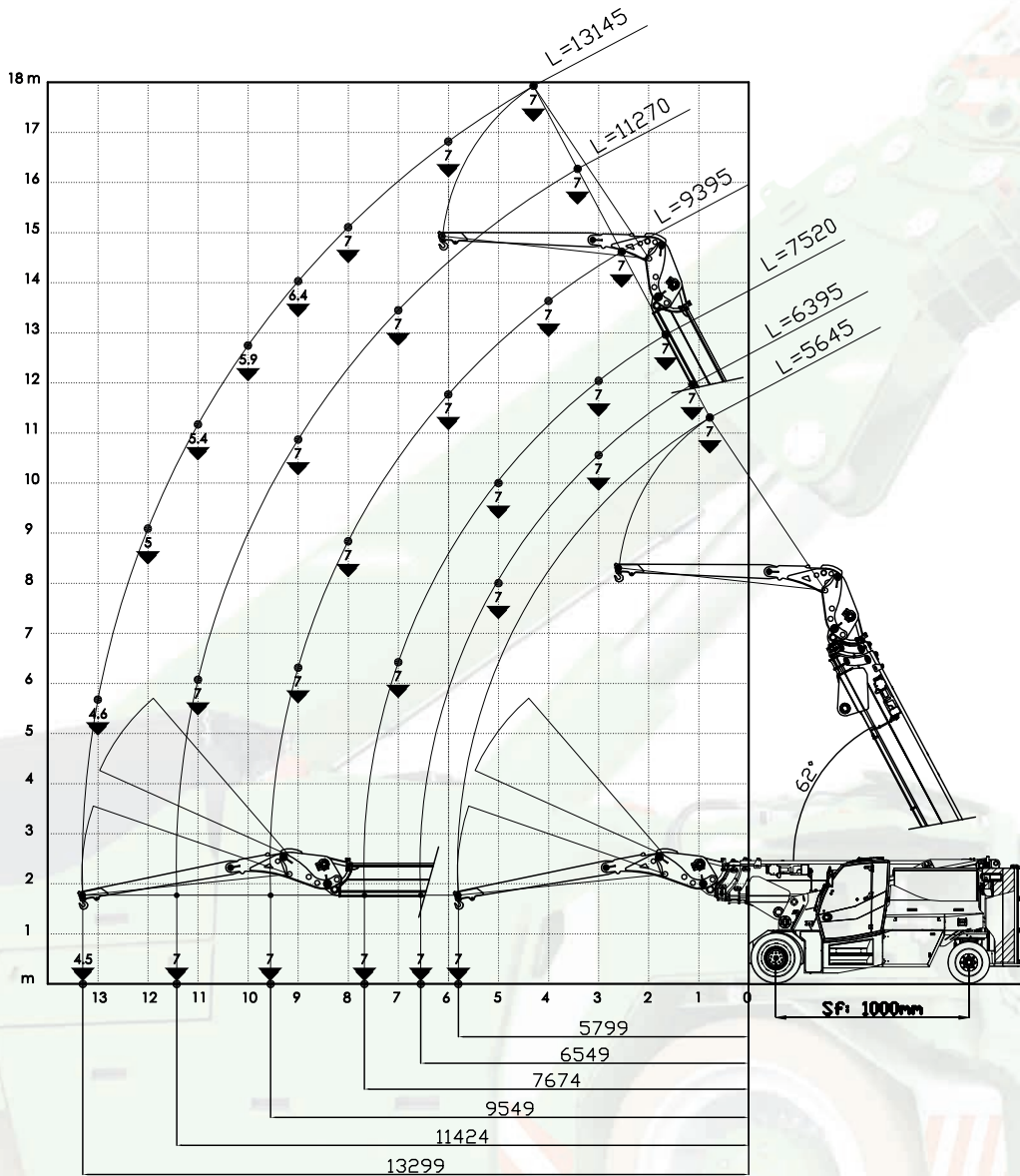

Lasttabellen



Verlängerung 7t@3m  
am Gelenk-Jib 35t@1.85m  
Haken / Seilwinde  
Offene Gruppe bei 1000 mm  
Position OBEN  
4 Ballaste

Maximale Tragfähigkeit  
Haken / Seilwinde: **7t**

# Verlängerung 7t@3m am Gelenk-Jib 35t@1.85m

N. MAX ROPE 2	
7 t	
SINGLE ROPE 1	
5,5 t	



Lasttabellen

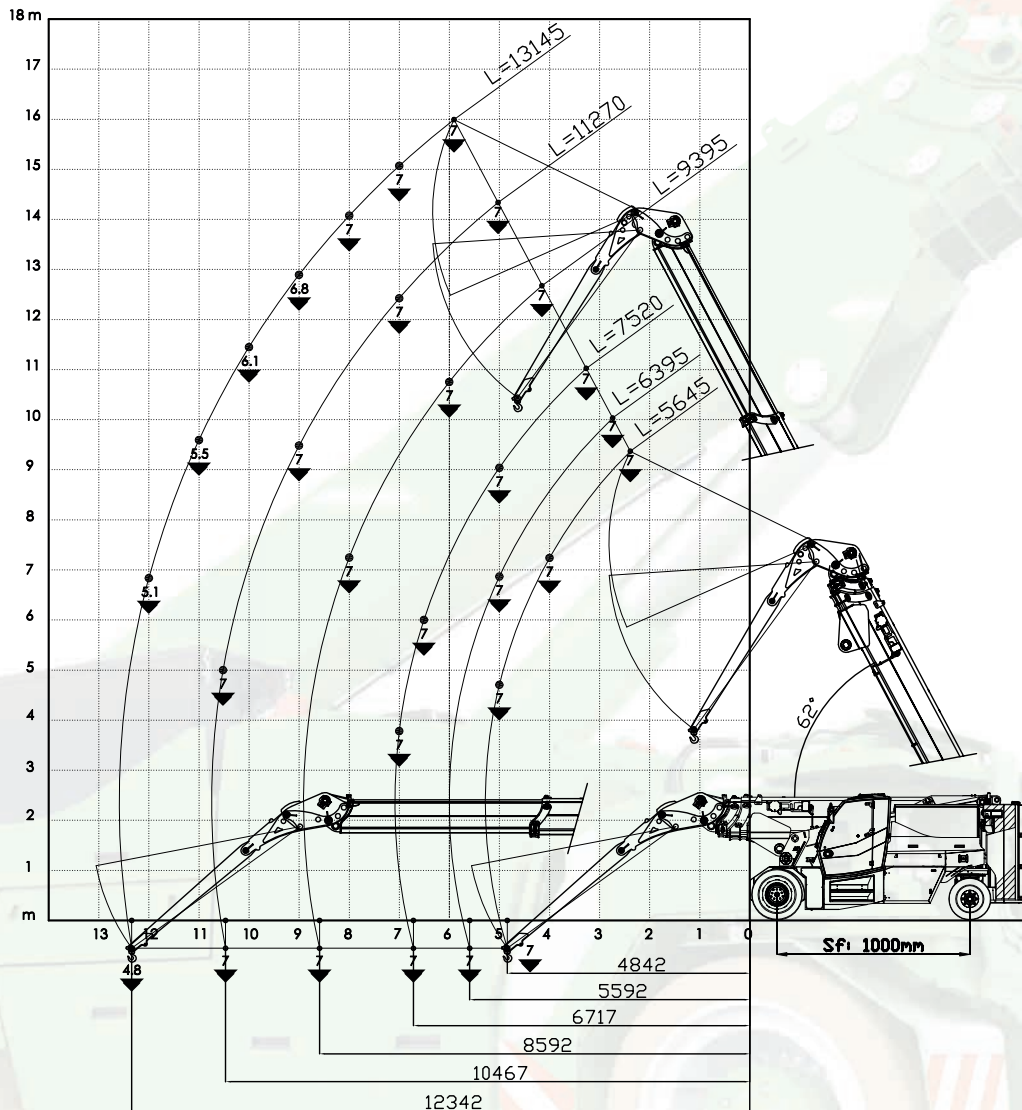



Verlängerung 7t@3m  
am Gelenk-Jib 35t@1.85m  
Haken / Seilwinde  
Offene Gruppe bei 1000 mm  
Position UNTEN  
4 Ballaste

Maximale Tragfähigkeit  
Haken / Seilwinde: **7t**





# Verlängerung 7t@3m am Gelenk-Jib 35t@1.85m



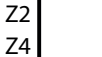

Maximale Tragfähigkeit  
Haken / Seilwinde: 7t

N. MAX ROPE	
7 t	
SINGLE ROPE	
5,5 t	

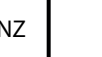

Lasttabellen

							
	(t)	5645	6395	7520	9395	11270	13145
	0,01						
	0,5						
	1						
	1,5	7					
	2	7	7				
	2,5	7	7	7			
	3	7	7	7			
	3,5	7	7	7	7		
	4	7	7	7	7	7	
	4,5	7	7	7	7	7	
	5	7	7	7	7	7	7
	5,5	7	7	7	7	7	7
	5,80	7	7	7	7	7	7
	6		7	7	7	7	7
	6,55		7	7	7	7	7
	7			7	7	7	7
	7,5			7	7	7	7
	7,67			7	7	7	7
	8				7	7	7
	8,5				7	7	6,7
	9				7	7	6,4
	9,55				7	7	6,1
	10					7	5,9
	10,5					7	5,6
	11					7	5,4
	11,42					7	5,2
	11,5						5,2
	12						5
	12,5						4,9
	13						4,6
	13,30						4,5



							
	(t)	5645	6395	7520	9395	11270	13145
	0,01						
	0,5						
	1						
	1,5	7					
	2	7	7				
	2,5	7	7	7			
	3	7	7	7			
	3,5	7	7	7	7		
	4	7	7	7	7	7	
	4,5	7	7	7	7	7	
	5	7	7	7	7	7	7
	5,5	7	7	7	7	7	7
	5,80	7	7	7	7	7	7
	6		7	7	7	7	7
	6,55		7	7	7	7	7
	7			7	7	7	7
	7,5			7	7	7	7
	7,67			7	7	7	7
	8				7	7	7
	8,5				7	7	6,7
	9				7	6,9	6,1
	9,55				7	6,5	5,6
	10					6,2	5,4
	10,5					6	5,1
	11					5,2	4,7
	11,42					5,2	4,5
	11,5						4,5
	12						4,2
	12,5						4
	13						3,5
	13,30						3,5

Verlängerung 7t@3m  
am Gelenk-Jib 35t@1.85m  
Haken / Seilwinde  
Offene Gruppe bei 1000 mm  
Position OBEN  
4 Ballaste

Verlängerung 7t@3m  
am Gelenk-Jib 35t@1.85m  
Haken / Seilwinde  
Offene Gruppe bei 1000 mm  
Position OBEN  
Offene Stab. bei 600 mm





# Verlängerung 7t@3m am Gelenk-Jib 35t@1.85m





Maximale Tragfähigkeit  
Haken / Seilwinde: 7t

N. MAX ROPE	
7 t	
SINGLE ROPE	
5,5 t	



Lasttabellen



				Z1 Z2 Z3 Z4
				
(t)	5645	6395	7520	9395 11270 13145
0,01				
0,5				
1				
1,5				
2				
2,5	7			
3	7	7		
3,5	7	7	7	
4	7	7	7	
4,5	7	7	7	7
4,84	7	7	7	7
5	7	7	7	7 7
5,5		7	7	7 7
5,59		7	7	7 7
6		7	7	7 7
6,5			7	7 7 7
6,72			7	7 7 7
7			7	7 7 7
7,5				7 7 7
8				7 7 7
8,5				7 7 7
8,59				7 7 7
9				7 6,8
9,5				7 6,4
10				7 6,1
10,47				7 5,8
10,5				7 5,8
11				5,5
11,5				5,3
12				5,1
12,34				4,8

				NZ
				
(t)	5645	6395	7520	9395 11270 13145
0,01				
0,5				
1				
1,5				
2				
2,5	7			
3	7	7		
3,5	7	7	7	
4	7	7	7	
4,5	7	7	7	7
4,84	7	7	7	7
5	7	7	7	7 7
5,5		7	7	7 7
5,59		7	7	7 7
6		7	7	7 7
6,5			7	7 7 7
6,72			7	7 7 7
7			7	7 7 7
7,5				7 7 7
8				7 7 7
8,5				7 7 7
8,59				7 7 7
9				7 6,8
9,5				6,9 6,3
10				6,5 5,8
10,47				5,5 5,4
10,5				5,5 5,4
11				5
11,5				4,7
12				4,3
12,34				3,8

Verlängerung 7t@3m  
am Gelenk-Jib 35t@1.85m  
Haken / Seilwinde  
Offene Gruppe bei 1000 mm  
Position UNTEN  
4 Ballaste

Verlängerung 7t@3m  
am Gelenk-Jib 35t@1.85m  
Haken / Seilwinde  
Offene Gruppe bei 1000 mm  
Position UNTEN  
Offene Stab. bei 600 mm

# Hydraulischer Jib 27t@1.5m

N. MAX ROPE	
27 t	
SINGLE ROPE	
5,5 t	



Lasttabellen

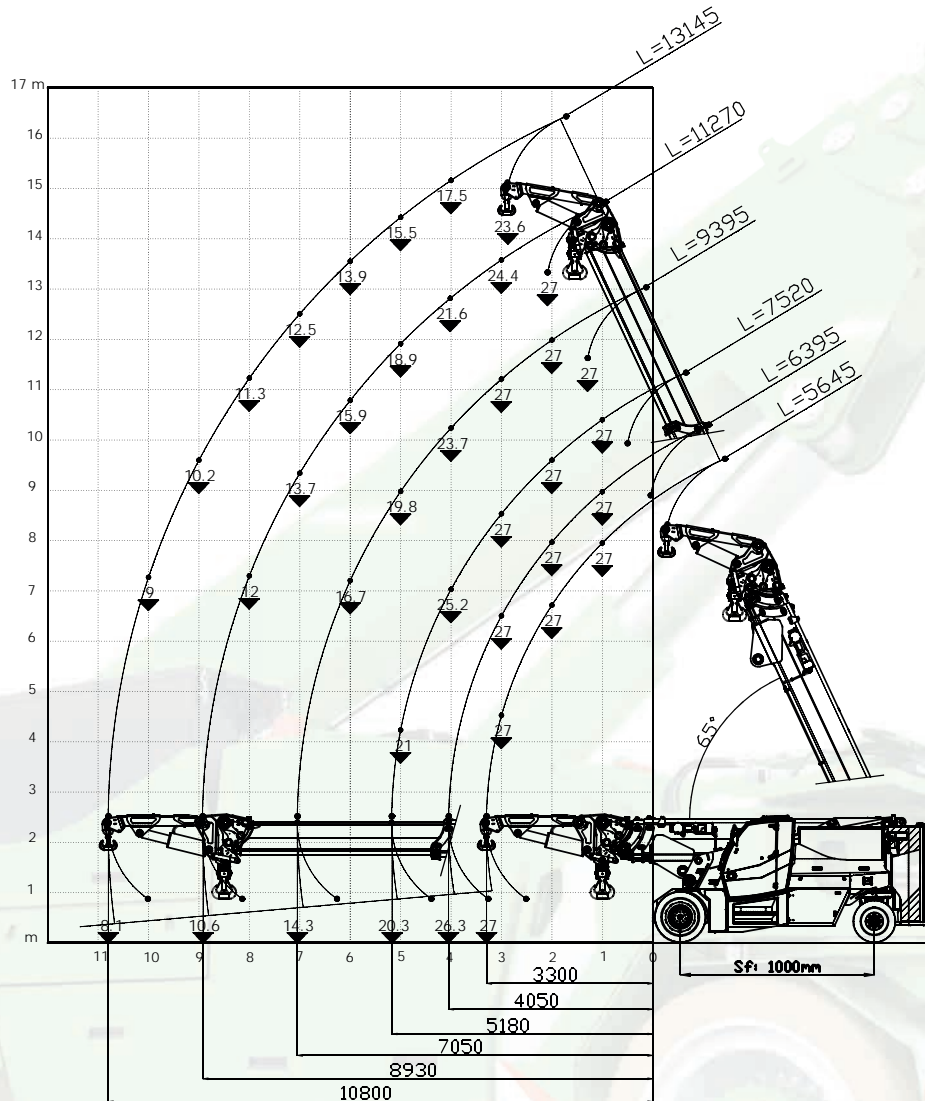



Hydraulischer Jib 27t@1.5m  
 Haken / Seilwinde  
 Offene Gruppe bei 1000 mm  
 4 Ballaste

Maximale Tragfähigkeit  
 Haken / Seilwinde: **27t**







# Hydraulischer Jib 27t@1.5m







Maximale Tragfähigkeit  
Haken / Seilwinde: **27t**

N. MAX ROPE	
27 t	
SINGLE ROPE	
5,5 t	



Lasttabellen



							
		1000mm	0mm	Z1	Z2	Z3	Z4
							
(t)		5645	6395	7520	9395	11270	13145
0		27	27	27	27		
0,5		27	27	27	27		
1		27	27	27	27	27	
1,5		27	27	27	27	27	23,6
2		27	27	27	27	27	23
2,5		27	27	27	27	25,8	21,4
3		27	27	27	27	24,4	19,9
3,3		27	27	27	27	23,5	19,2
3,5			27	27	26,1	23	18,7
4			26,5	25,2	23,7	21,6	17,5
4,05			26,3	25	23,4	21,5	17,4
4,5				22,9	21,5	20,5	16,5
5				21	19,8	18,9	15,5
5,17				20,3	19,1	18,2	15,2
5,5					18,1	17,3	14,7
6					16,7	15,9	13,9
6,5					15,5	14,8	13,2
7					14,4	13,7	12,5
7,05					14,3	13,6	12,4
7,5						12,8	11,9
8						12	11,3
8,5						11,2	10,8
8,92						10,6	10,3
9							10,2
9,5							9,6
10							9
10,5							8,5
10,8							8,1

							
		1000mm	600mm	NZ			
							
(t)		5645	6395	7520	9395	11270	13145
0		27	27	27	27		
0,5		27	27	27	27		
1		27	27	27	27	27	
1,5		27	27	27	27	27	23,6
2		27	27	27	27	27	23
2,5		27	27	27	26,9	25,1	21,4
3		27	26,5	24,4	22,7	21,3	19,9
3,3		25,6	23,9	22,3	20,6	19,4	18,4
3,5			22,7	20,8	19,5	18,2	17,3
4			19,6	18,1	16,8	15,8	15,1
4,05			19,2	17,9	16,7	15,7	14,9
4,5				16	14,9	14	13,3
5				14,2	13,2	12,4	11,8
5,17				13,7	12,6	11,9	11,4
5,5					11,7	11	10,5
6					10,5	9,9	9,5
6,5					9,5	9	8,5
7					8,7	8,1	7,7
7,05					8,6	8,1	7,7
7,5						7,4	7
8						6,7	6,4
8,5						6,2	5,8
8,92						5,7	5,4
9							5,3
9,5							4,9
10							4,5
10,5							4,1
10,8							3,9

Hydraulischer Jib 27t@1.5m  
Haken / Seilwinde  
Offene Gruppe bei 1000 mm  
4 Ballaste

Hydraulischer Jib 27t@1.5m  
Haken / Seilwinde  
Offene Gruppe bei 1000 mm  
Offene Stab. bei 600 mm

# Verlängerung 15t@1.5m am hydraulischem Jib 27t@1.5m

N. MAX ROPE ↗	
15 t	
SINGLE ROPE ↘	
5,5 t	



Lasttabellen

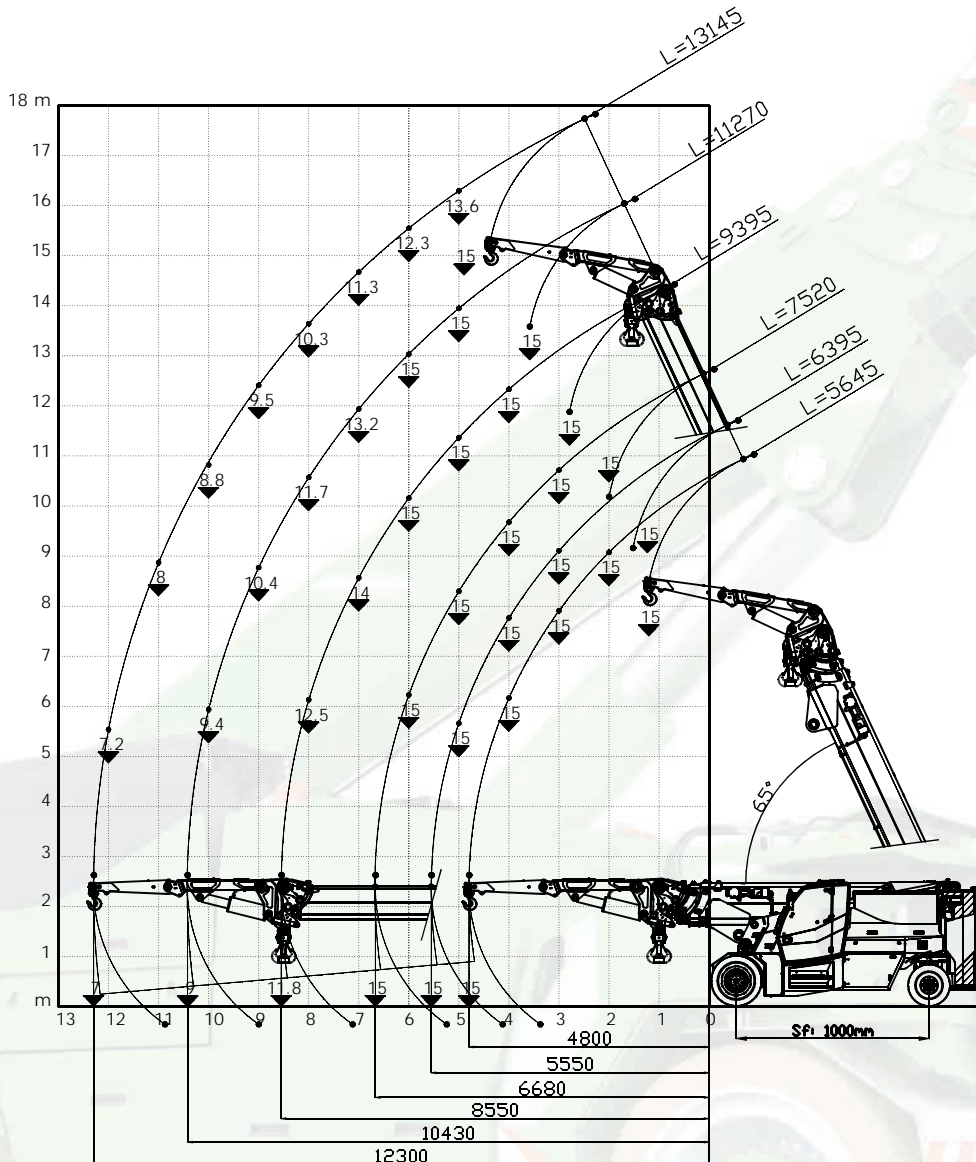



Verlängerung 15t@1.5m  
am hydraulischem Jib 27t@1.5m  
Haken / Seilwinde  
Offene Gruppe bei 1000 mm  
4 Ballaste

Maximale Tragfähigkeit  
Haken / Seilwinde: **15t**





# Verlängerung 15t@1.5m am hydraulischem Jib 27t@1.5m





Maximale Tragfähigkeit  
Haken / Seilwinde: **15t**

N. MAX ROPE ↙	
15 t	
SINGLE ROPE ↘	
5,5 t	



Lasttabellen

					Z1 Z3	Z2 Z4	
		1000mm		0mm			
							
	(t)	5645	6395	7520	9395	11270	13145
	0	15	15	15	15		
	1	15	15	15	15	15	
	2	15	15	15	15	15	15
	3	15	15	15	15	15	15
	4	15	15	15	15	15	15
	4,8	15	15	15	15	15	13,8
	5		15	15	15	15	13,6
	5,55		15	15	15	15	12,9
	6			15	15	15	12,3
	6,68			15	14,6	13,8	11,6
	7				14	13,2	11,3
	8				12,5	11,7	10,3
	8,55				11,8	10,9	9,9
	9					10,4	9,5
	10					9,4	8,8
	10,43					9	8,5
	11						8
	12						7,2
	12,3						7

					NZ		
		1000mm		600mm			
							
	(t)	5645	6395	7520	9395	11270	13145
	0	15	15	15	15		
	1	15	15	15	15	15	
	2	15	15	15	15	15	15
	3	15	15	15	15	15	15
	4	15	15	15	14,9	13,8	13,1
	4,8	15	15	13,9	12,7	11,8	11,1
	5		14,6	13,4	12,2	11,3	10,6
	5,55		13,3	12,1	11	10,2	9,5
	6			11,2	10,2	9,4	8,8
	6,68			10	9,1	8,4	7,8
	7				8,6	7,9	7,4
	8				7,4	6,7	6,3
	8,55				6,8	6,2	5,7
	9					5,7	5,3
	10					4,9	4,6
	10,43					4,6	4,2
	11						3,9
	12						3,3
	12,3						3,2

Verlängerung 15t@1.5m  
am hydraulischem Jib 27t@1.5m  
Haken / Seilwinde  
Offene Gruppe bei 1000 mm  
4 Ballaste

Verlängerung 15t@1.5m  
am hydraulischem Jib 27t@1.5m  
Haken / Seilwinde  
Offene Gruppe bei 1000 mm  
Offene Stab. bei 600 mm

# Gabeln 26t@1.2m



Lasttabellen

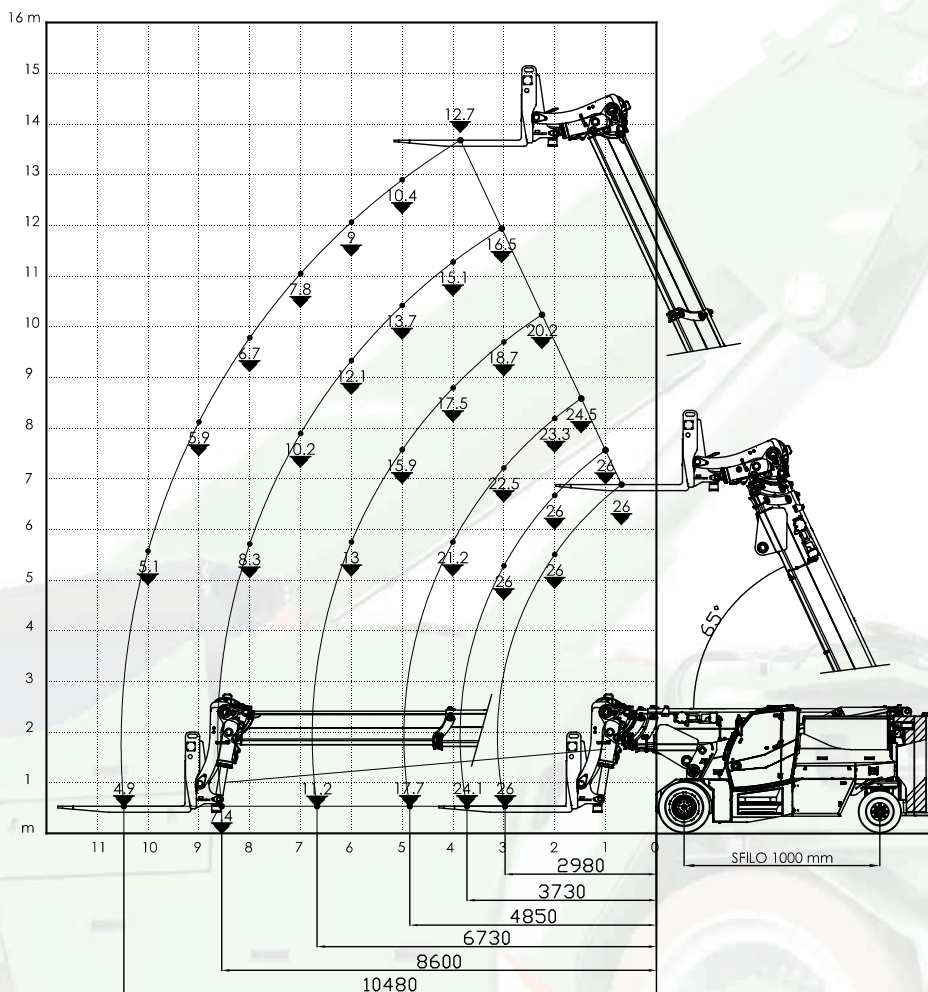

Gabeln 26t@1.2m  
Offene Gruppe bei 1000 mm  
4 Ballaste

Maximale Tragfähigkeit  
**26t**

# Gabeln 26t@1.2m



Lasttabellen

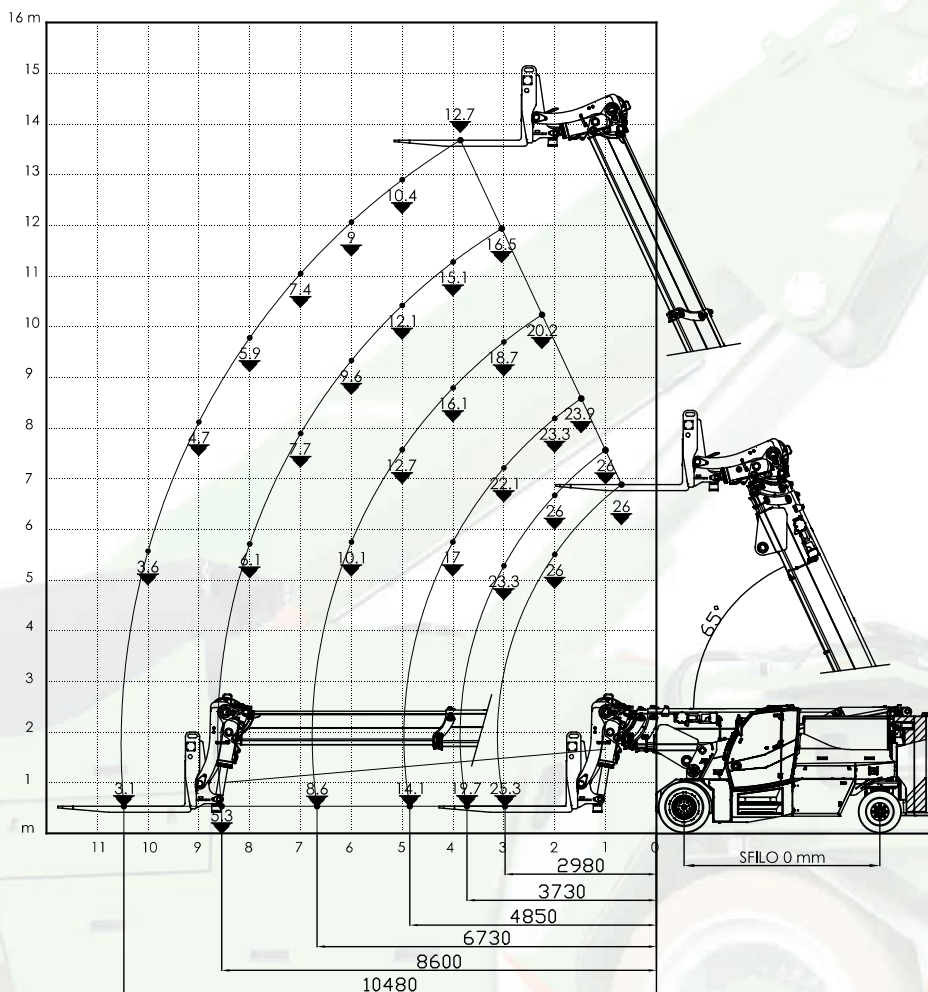

Gabeln 26t@1.2m  
Gruppe geschlossen  
4 Ballaste





Maximale Tragfähigkeit  
**26t**





# Gabeln 26t@1.2m

## Maximale Tragfähigkeit 26t



## Lasttabellen

								Z1	Z2
		1000mm		0mm		Z3	Z4		
									
		(t)	5645	6395	7520	9395	11270	13145	
0		26	26						
0,5		26	26	25,1					
1		26	26	24,5	21,1				
1,5		26	26	23,9	21				
2		26	26	23,3	20,2	17,8			
2,5		26	26	22,8	19,4	17,3			
2,98		26	26	22,5	18,8	16,5	14,3		
3			26	22,5	18,7	16,5	14,3		
3,5			25,1	22,2	18,1	15,8	13,2		
3,73			24,1	22,1	17,8	15,4	12,7		
4				21,2	17,5	15,1	12,2		
4,5				18,9	17	14,5	11,3		
4,85				17,7	16,5	13,9	10,7		
5					15,9	13,7	10,4		
5,5					14,3	12,8	9,7		
6					13	12,1	9		
6,5					11,7	11,2	8,4		
6,73					11,2	10,7	8,1		
7						10,2	7,8		
7,5						9,2	7,2		
8						8,3	6,7		
8,5						7,6	6,3		
8,6						7,4	6,2		
9							5,9		
9,5							5,5		
10							5,1		
10,48							4,9		

								Z1	Z2
		1000mm		600mm		Z3	Z4		
									
		(t)	5645	6395	7520	9395	11270	13145	
0		26	26						
0,5		26	26	25,1					
1		26	26	24,5	21,1				
1,5		26	26	23,9	21				
2		26	26	23,3	20,2	17,8			
2,5		26	26	22,8	19,4	17,3			
2,98		26	26	22,5	18,8	16,5	14,3		
3			26	22,5	18,7	16,5	14,3		
3,5			26	22,2	18,1	15,8	13,2		
3,73			26	22,1	17,8	15,4	12,7		
4				22,1	17,5	15,1	12,2		
4,5				22,1	17	14,5	11,3		
4,85				22,1	16,7	13,9	10,7		
5					16,6	13,7	10,4		
5,5					16	12,8	9,7		
6					15,2	12,1	9		
6,5					14,6	11,4	8,4		
6,73					14,6	11,1	8,1		
7						10,7	7,8		
7,5						10,1	7,2		
8						9,5	6,7		
8,5						9	6,3		
8,6						9	6,2		
9							5,9		
9,5							5,5		
10							5,1		
10,48							4,9		

### Gabeln 26t@1.2m

Offene Gruppe bei 1000 mm  
4 Ballaste

### Gabeln 26t@1.2m

Offene Gruppe bei 1000 mm  
2 Ballaste + offene Stab. 600 mm